

! INFO !

- (DE) Die Batterie des Zugfahrzeugs bzw. gezogenen Fahrzeugs nicht direkt über die Steckdose aufladen.
- (FR) Ne pas charger les batteries du véhicule tracteur et/ou tracté directement sur la prise de courant.
- (NL) De accu van het trekkend voertuig c.q. getrokken voertuig niet rechtstreeks via de contactdoos opladen.
- (GB) Do not charge the battery of the towing vehicle and/or towed vehicle directly via the socket.
- (ES) No recargue la batería del vehículo remolque y/o del remolcado directamente mediante el enchufe.
- (IT) Non caricare la batteria del veicolo trainante o di quello trainato direttamente dalla presa.
- (SE) Ladda inte batteriet i det bogserande fordonet och/eller det bogserade fordonet direkt via kontakten.
- (CZ) Nenabíjajte baterii tažného ani taženého vozidla přes zásuvku.
- (DK) Oplad ikke bugseringskøretøjet og/eller det bugserede køretøjs batteri direkte v.h.a. stikdåsen.
- (FI) Älä lataa hinaavan ajoneuvon ja/tai hinattavan ajoneuvon akkuja suoraan pistorasian kautta.
- (GR) Μη φορτίζετε την μπαταρία του ρυμουλκούμενου οχήματος και/ή ρυμουλκημένου οχήματος απευθείας μέσω του ρευματοδότη.
- (NO) Batteriet til kjøretøyet som trekker eller blir trukket skal ikke lades direkte via koblingsboksen.
- (PL) Nie ładować akumulatora pojazdu holującego/holowanego bezpośrednio przez gniazdo.

- (DE) Gebrauchsanleitung
(FR) Mode d'emploi
(NL) Gebruikershandleiding
(GB) User guide
(ES) Guía del usuario
(IT) Manuale di istruzioni
(SE) Bruksanvisning
(CZ) Uživatelská příručka
(DK) Brugervejledning
(FI) Käyttöohjeet
(GR) Οδηγός χρήστη
(NO) Brukerveiledning
(PL) Instrukcja obsługi

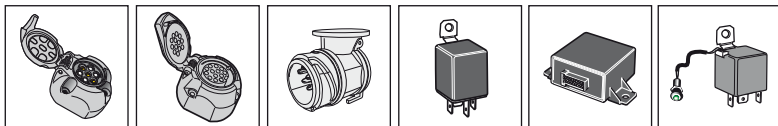
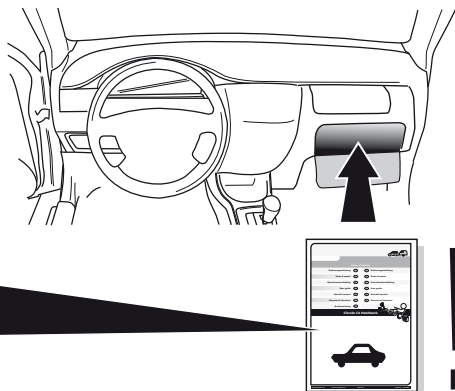

SPARE PARTS

www.ecs-electronics.nl



Partnr.: OP-054-DL

Gebrauchsanleitung (DE)

(CZ) Uživatelská příručka

Mode d'emploi (FR)

(DK) Brugervejledning

Gebruikershandleiding (NL)

(FI) Käyttöohjeet

User guide (GB)

(GR) Οδηγός χρήστη

Guía del usuario (ES)

(NO) Brukerveiledning

Manuale di istruzioni (IT)

(PL) Instrukcja obsługi

Bruksanvisning (SE)

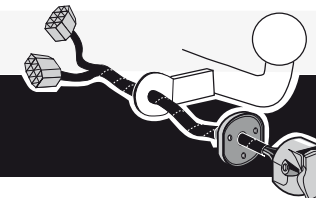

Opel Movano Van / Bus 03/2010 >> 12/2021
Renault Master Van / Bus 03/2010 >> 05/2024
Nissan NV400 Van / Bus 03/2010 >> 12/2021
Nissan Interstar Van / Bus 01/2022 >> 05/2024

Vehicles with & without trailer-preparation!

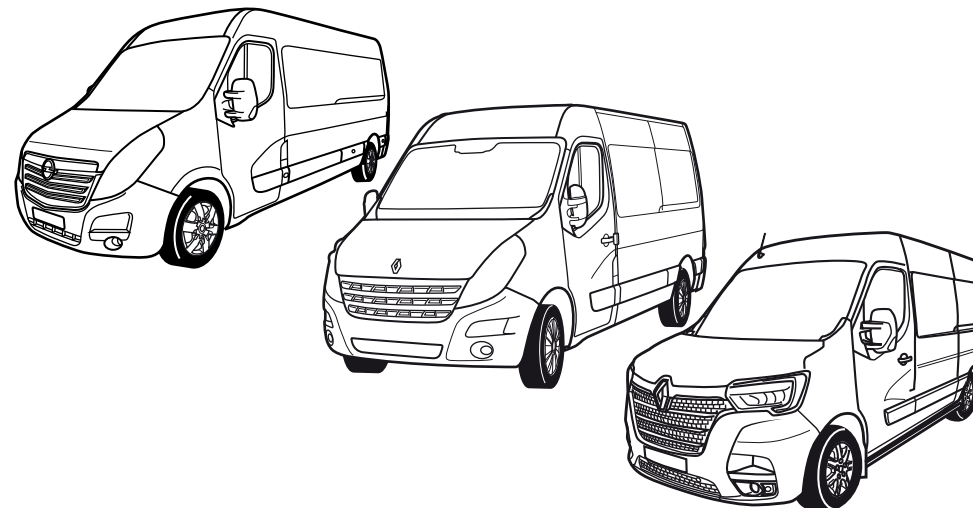

INFO : Storage

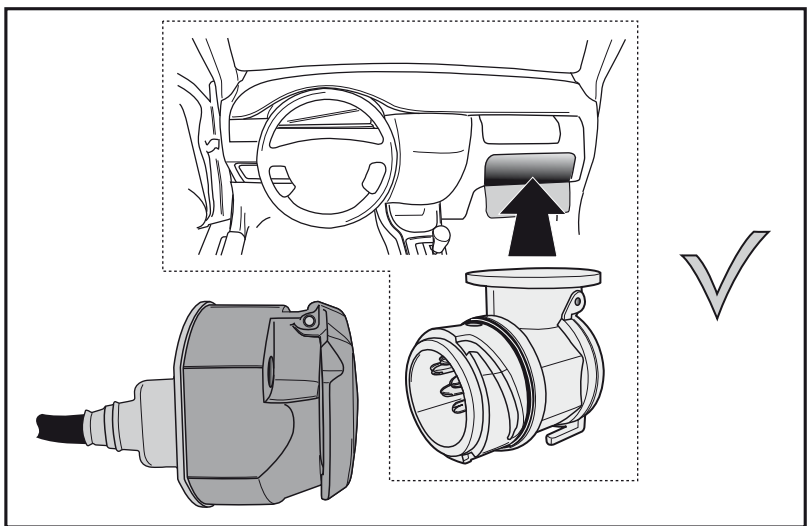
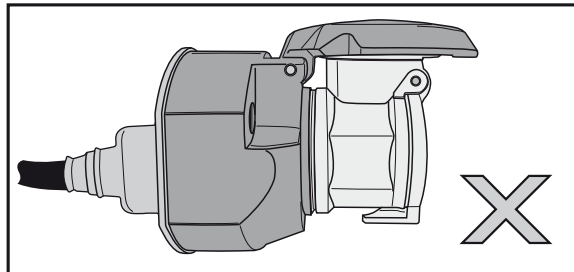
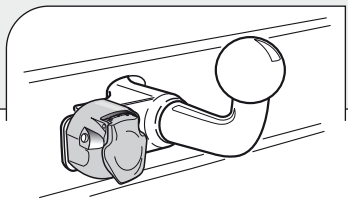
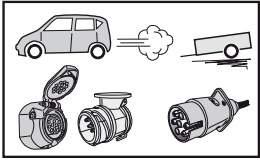

INFO

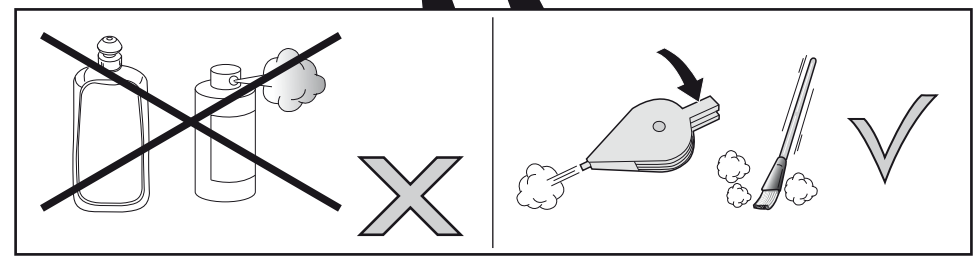
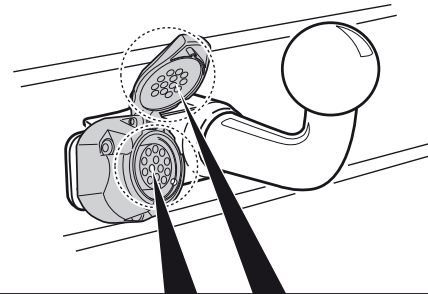
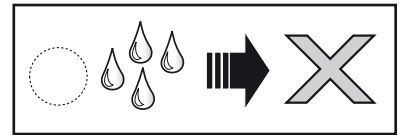
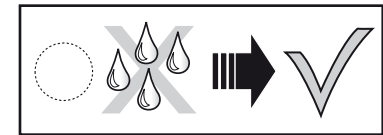
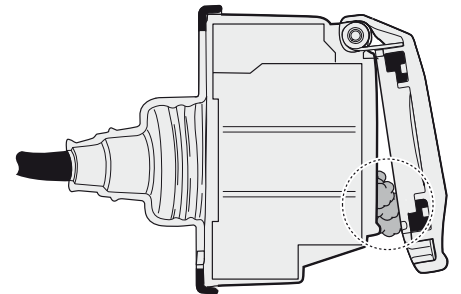
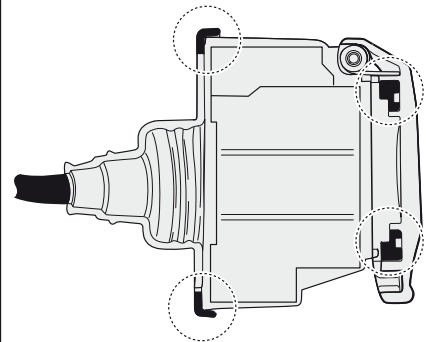
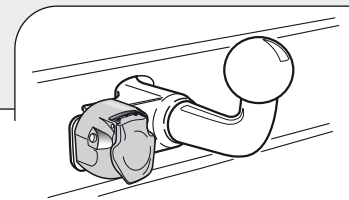
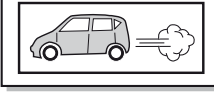

INFO : Ring.

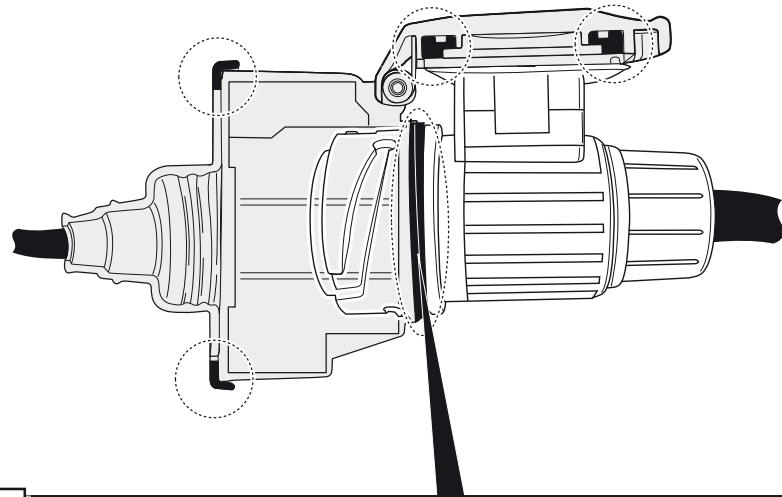
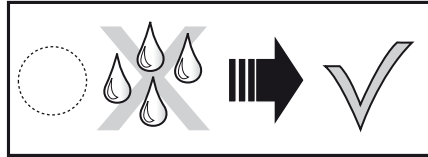
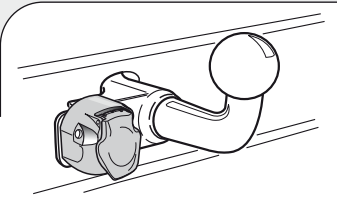
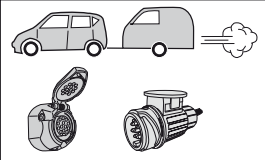

INFO

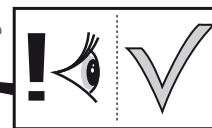
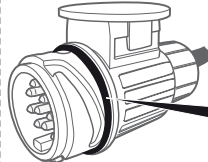
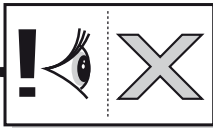
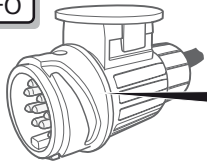

INFO : Adapt.

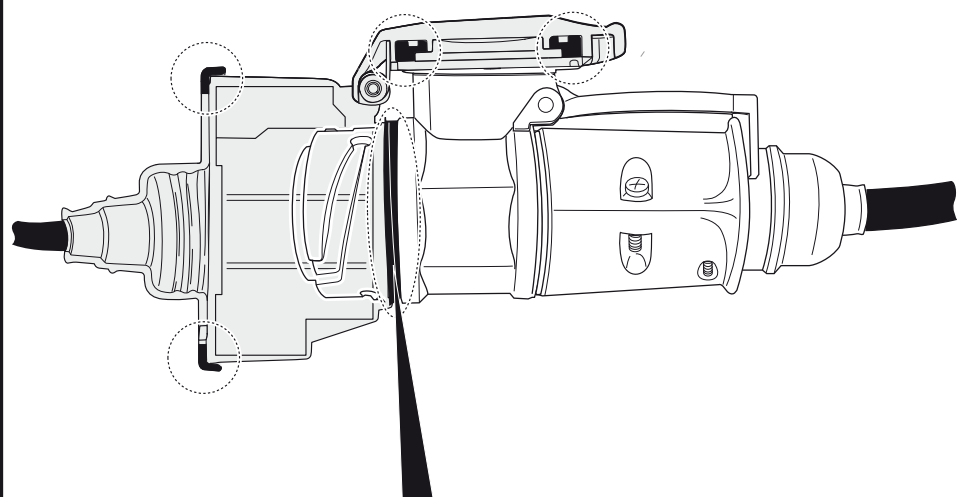
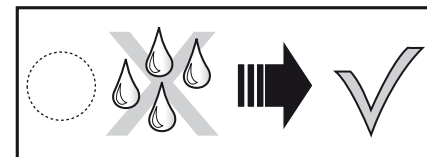
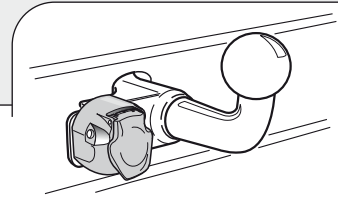
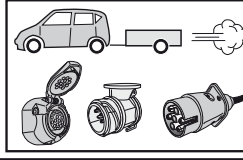

INFO

